

CLOUD 100/70 V TRANSFORMERS

TYPES: CXL-40T, CXL-100T, CXL-200T & CXL-400T
 RACKMOUNT HOUSINGS: CXL-800 & CXL-1600

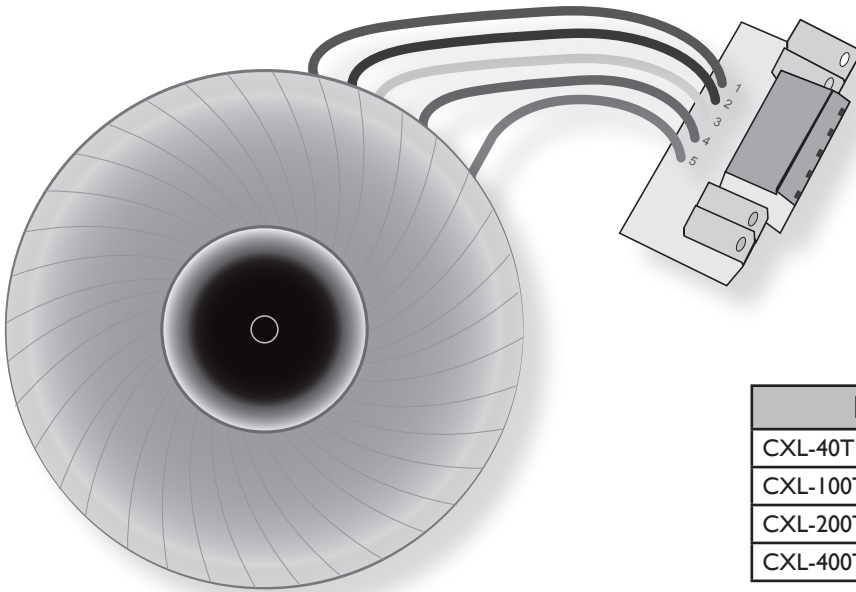

Model	Dimensions / Weight
CXL-40T	65 mm (dia) x 30 mm (h) / 0.45 kg
CXL-100T	80 mm (dia) x 36 mm (h) / 0.9 kg
CXL-200T	100 mm (dia) x 65 mm (h) / 2.2 kg
CXL-400T	120 mm (dia) x 66 mm (h) / 3.4 kg

General Description

The CXL-40T, CXL-100T, CXL-200T and CXL-400T are 100/70 V toroidal transformer assemblies intended for use with certain Cloud power amplifiers and mixer amplifiers. They permit the amplifiers to drive 100 V-line or 70 V-line loudspeaker systems.

The transformers are intended to be mounted externally of the amplifier. Mounting is via a single M6 bolt (supplied) through the transformer core. It is recommended that the CXL-800 or CXL-1600 rackmount housings are used in conjunction with the transformers, as the complete assembly will provide good safety protection (see NOTE). The transformers' input and outputs are on 2-pin and 3-pin

(respectively) PCB mounted female screw-terminal connectors. This PCB is on a flying lead and is designed for simple two-screw fitment into the rackmount housing.

NOTE: It should be recognised that 100 V- or 70 V-line speaker systems have the potential to deliver an electric shock. Used correctly, the CXL-800 and CXL-1600 help in preventing such shocks by limiting access to the 70/100 V-line terminals. However the wiring of the transformers and associated speakers will need to comply with local electrical regulations for AC voltages up to 100V_{rms} (141 V_{peak}).

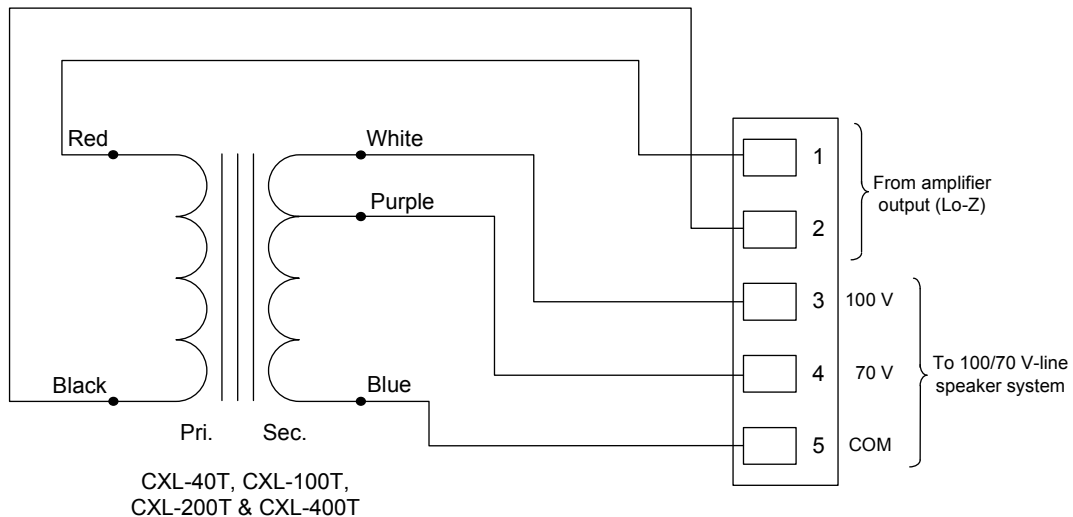

Current compatible Cloud products:

TRANSFORMER	MODEL	
CXL-40T	CX-A850	8 channel amplifier
	CX-A450	4 channel amplifier
	46/50	4 zone mixer-amplifier
	36/50	2 zone (+ utility) mixer amplifier
CXL-100T*	CX-A6	6 channel amplifier
	VTX4120	4 channel amplifier
CXL-200T	VTX4240	4 channel amplifier
CXL-400T	VTX4400	4 channel amplifier

*The CXL-100T is also compatible with the CX-A4 4 channel amplifier (discontinued model).

Low-frequency operation

All the Cloud products listed above are fitted with switchable high-pass filters in each audio channel, to remove low-frequency content from the programme material. Cloud recommend that these filters are always enabled in amplifier channels used to drive 100 V-line or 70 V-line systems, to avoid transformer core saturation at high

audio levels. This applies particularly if the channels are being used for music.

The filters are enabled by internal jumpers, and full instructions can be found in the individual product manuals.

Technical Specifications

	CXL-40T	CXL-100T	CXL-200T	CXL-400T
Maximum output power rating	40 W	100 W	200 W	400 W
Fixing	single M6 bolt (supplied)			
Connector type	5 mm-pitch screw terminals; 1 x 2-pin, 1 x 3-pin			
Lead length	165 mm			
Dimensions (mm)	65 (dia) x 30 (h)	80 (dia) x 36 (h)	100 (dia) x 65 (h)	120 (dia) x 66 (h)
Weight	0.45 kg	0.9 kg	2.2 kg	3.4 kg

Graphs

CXL-40T Frequency Response, 250 Ohms load, 40W

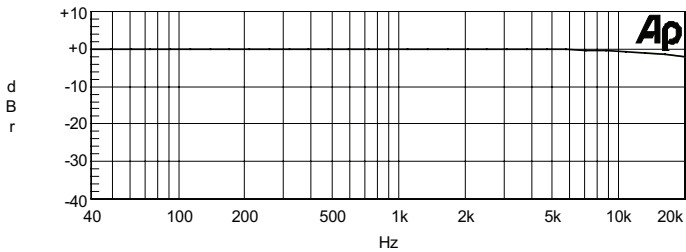

CXL-40T THD+N, 250 Ohms load, 40W, BW 80KHz

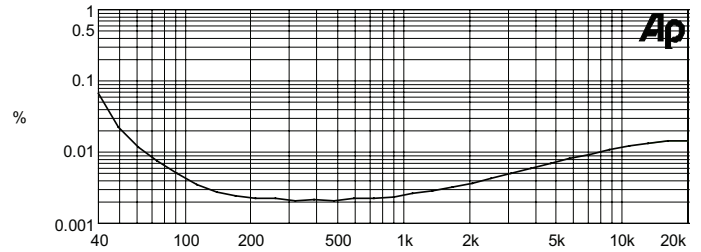

CXL100T, CX-A6 CH1, Frequency Response, 100 Ohms, 100W

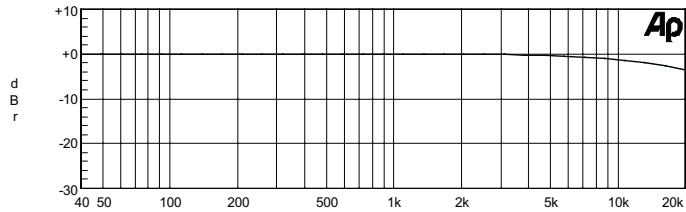

CXL100T, CX-A6 CH1, THD+N, 100 Ohms, 100W, BW 80KHz

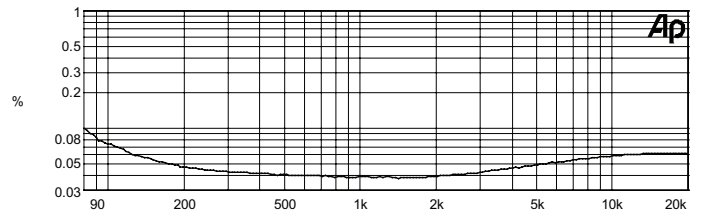

CXL200T & VTX4240 CH1 Frequency Response, 50 Ohms, 200W

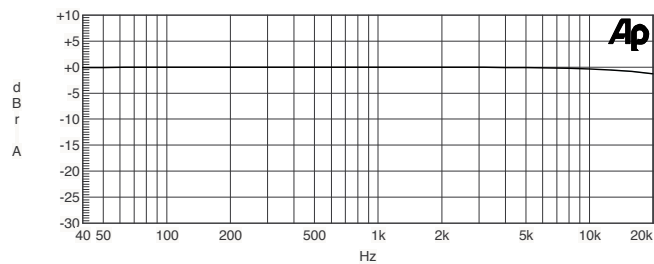

CXL200T & VTX4240 CH1 THD+N, 50 Ohms, 200W, BW 80kHz

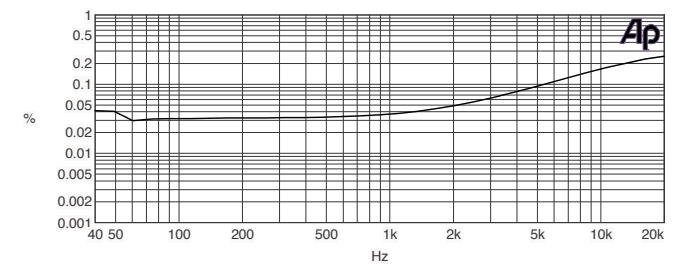

CXL400T & VTX4400 CH1 Frequency Response, 25 Ohms, 400W

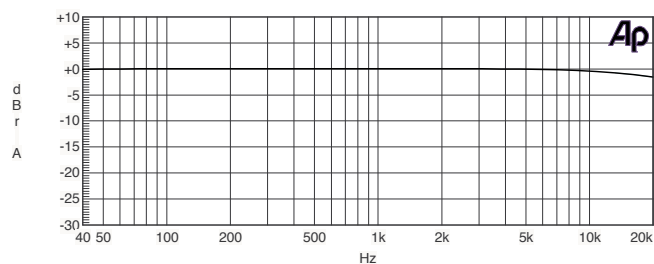

CXL400T & VTX4400 CH1 THD+N, 25 Ohms, 400W, BW 80kHz

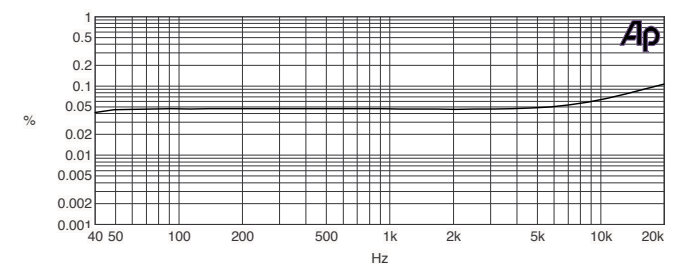

CXL-800 and CXL-1600 General Description

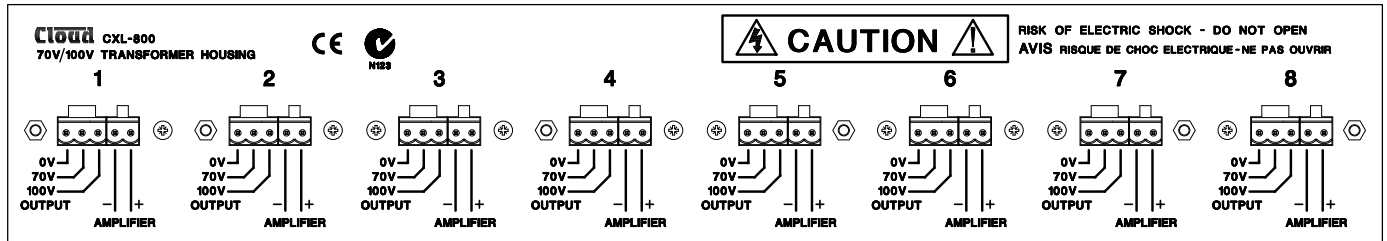

Cloud CXL-800 rear view (CXL-1600 rear view is identical)

The Cloud CXL-800 and CXL-1600 are 2U, 19" rack-mounting steel housings designed to accommodate Cloud CXL series transformers. They match other Cloud products cosmetically and provide the most convenient method of mounting transformers used in conjunction with multichannel 100 V/70 V-line systems. Both housings have a depth of 221 mm.

The CXL-800 is of open construction and is designed to accommodate up to eight CXL-40T or CXL-100T transformers (including a mixture of the two models).

The CXL-1600 is of more substantial construction, in the form of a fully sealed enclosure with top and side ventilation grilles. This design provides a greater degree of safety protection, as the transformers are fully enclosed, and is also more suited for the extra weight of the higher power transformers. The CXL-1600 can accommodate up to four CXL-200T or CXL-400T transformers (including a mixture of the two), or up to eight CXL-40T or CXL-100Ts (or a mixture of the two). It is also possible to fit various other combinations; the table below summarises the maximum quantity of each transformer type that may be fitted when the two sizes (CXL-200T/400T and CXL-40T/100T) are mixed:

CXL-1600 TRANSFORMER CAPACITY	
CXL-200T or CXL-400T	CXL-100T or CXL-40T
4	0
3	1
2	4
1	5
0	8

The housings' rear panels are pre-punched to accept the connector PCBs attached to the transformers, and is accordingly silk-screened with connection details. The base panel is pre-drilled for the transformers' M6 mounting bolts.

Correct use of the CXL-800 or CXL-1600 will assist the installer in meeting safety regulations relevant to wiring 100V/70V-line systems.

Architect's and Engineer's Specification

A range of transformers shall be available to enable individual channels of compatible Cloud amplifiers and mixer-amplifiers to drive 100 V-line or 70 V-line loudspeaker systems. The transformers shall be of toroidal design and versions shall be available which are suitable for amplifiers with per-channel power ratings of 40 W, 100 W, 200 W or 400 W. The transformers shall have electrically isolated primary and secondary windings and the windings shall be extended on flying leads and terminated in multi-pin screw-terminal connectors.

Steel housings shall also be available to mount multiple transformers of all the types in the range. The housings shall be suitable for installation in a standard 19" equipment rack. The housings will be provided with a method of permanently mounting the transformers' multi-pin connectors. The housings shall be of such a design that no accidental access to the transformer output terminals is possible.